

KSPCALI 160

QUINCAILLERIE

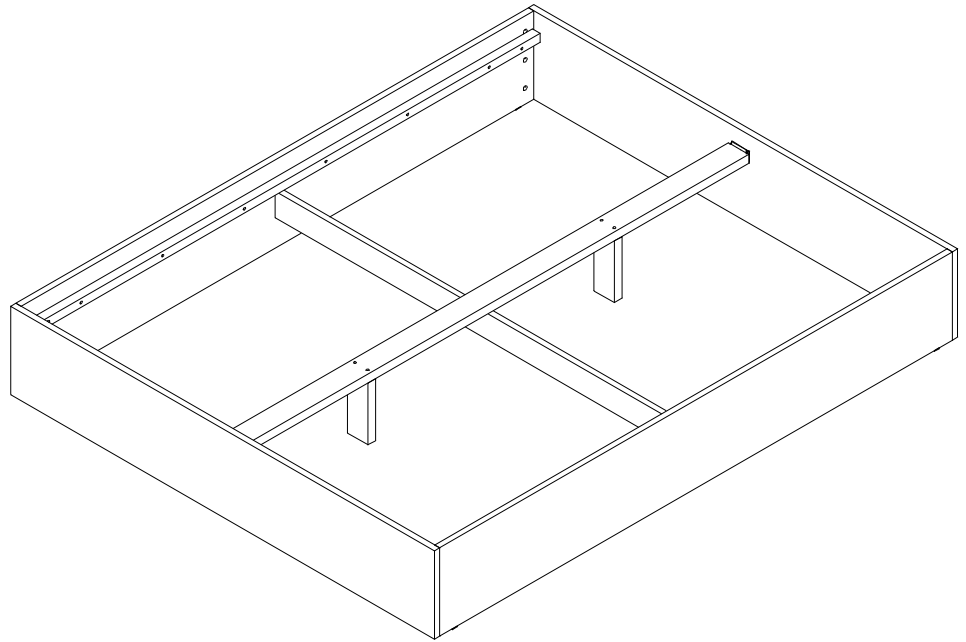

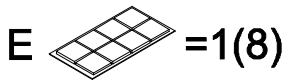

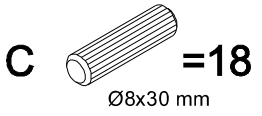
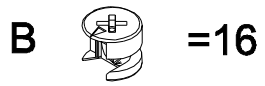
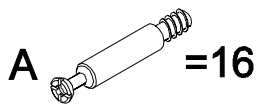

1 = 2

2 = 2

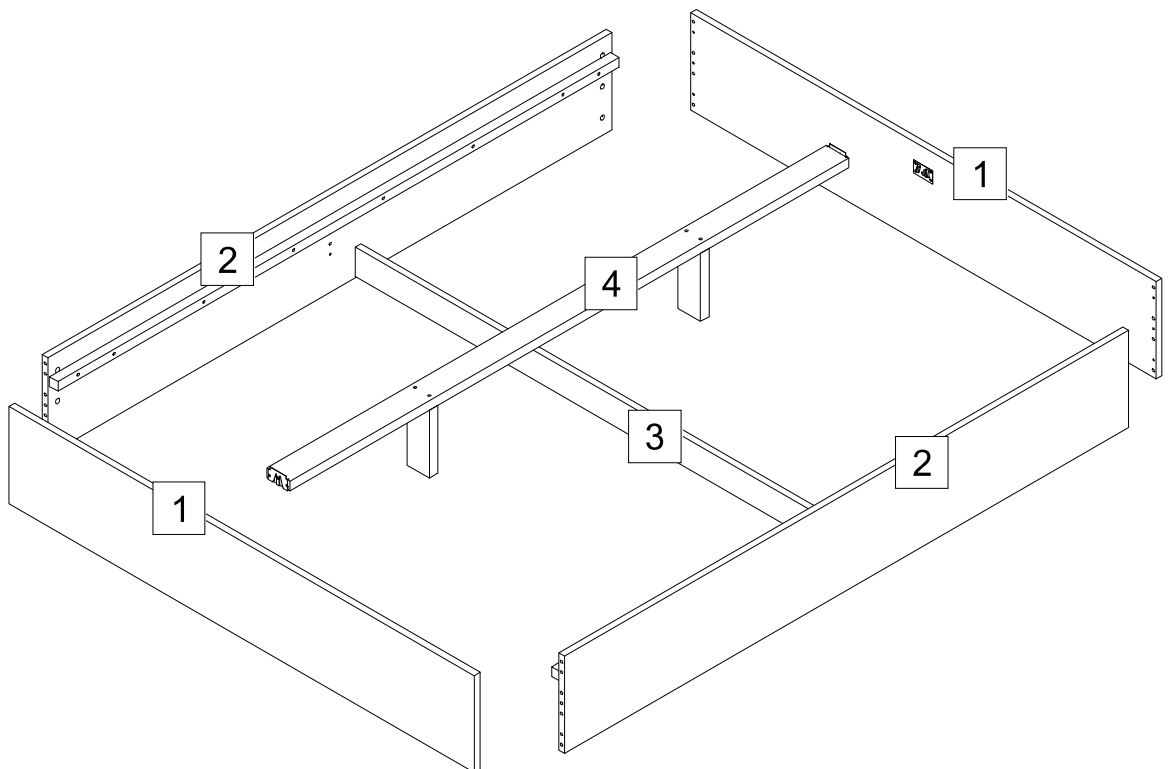
3 = 1

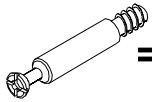

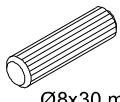

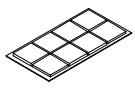
4 = 1

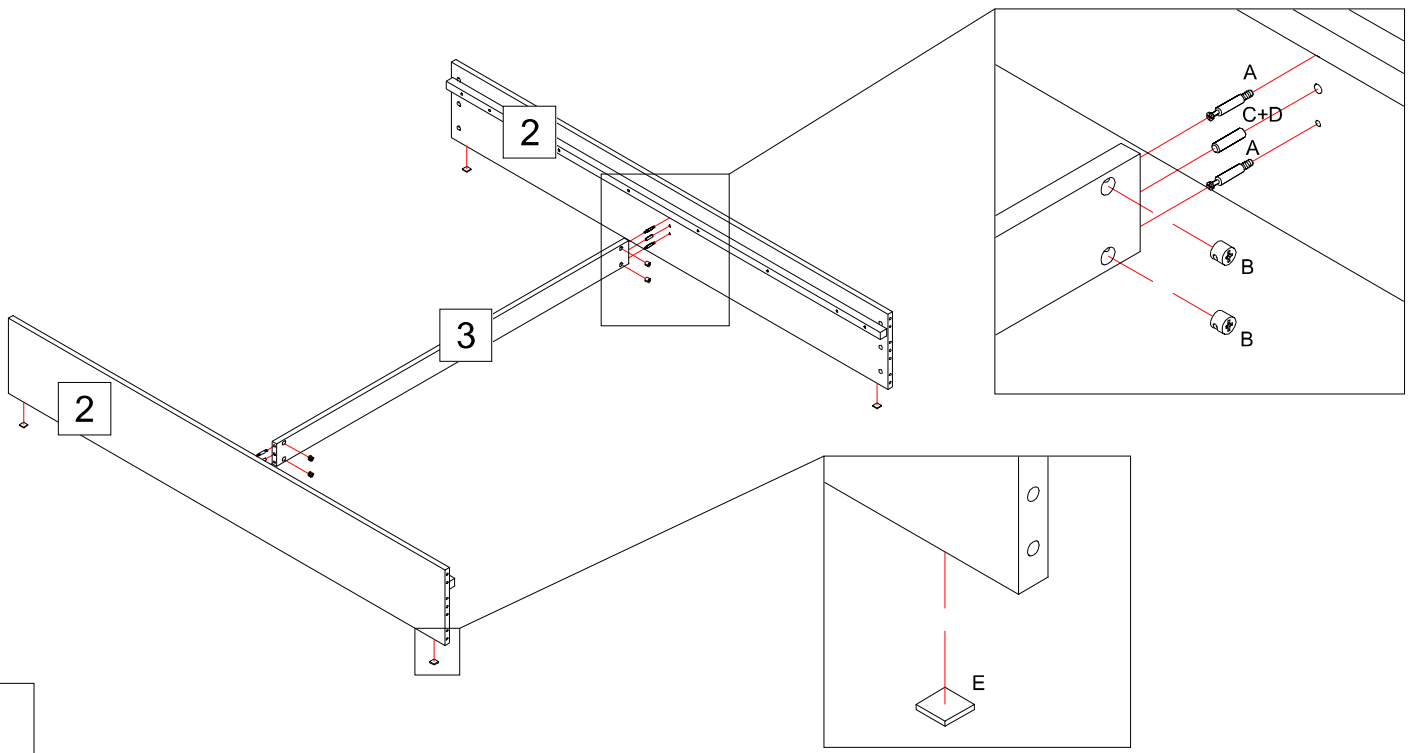

- A**  =4
- B**  =4
- C**  =2
Ø8x30 mm
- D**  =1
GLUE
- E**  =1(8)

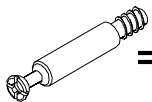

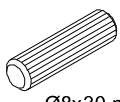
1

- A**  =12
- B**  =12
- C**  =16
Ø8x30 mm
- D**  =1
GLUE

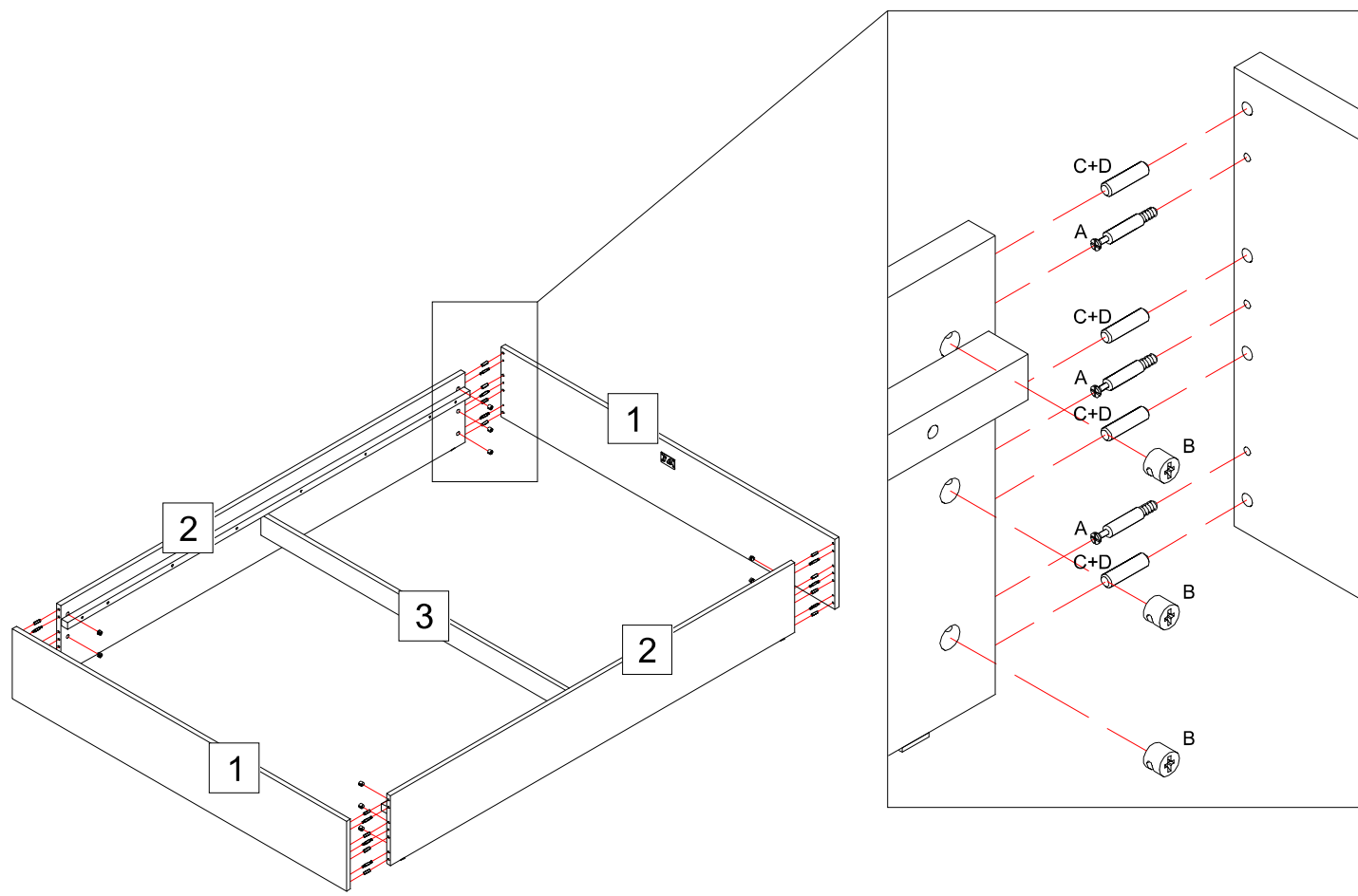

2

